

HF1123, HF1124 and HF1125

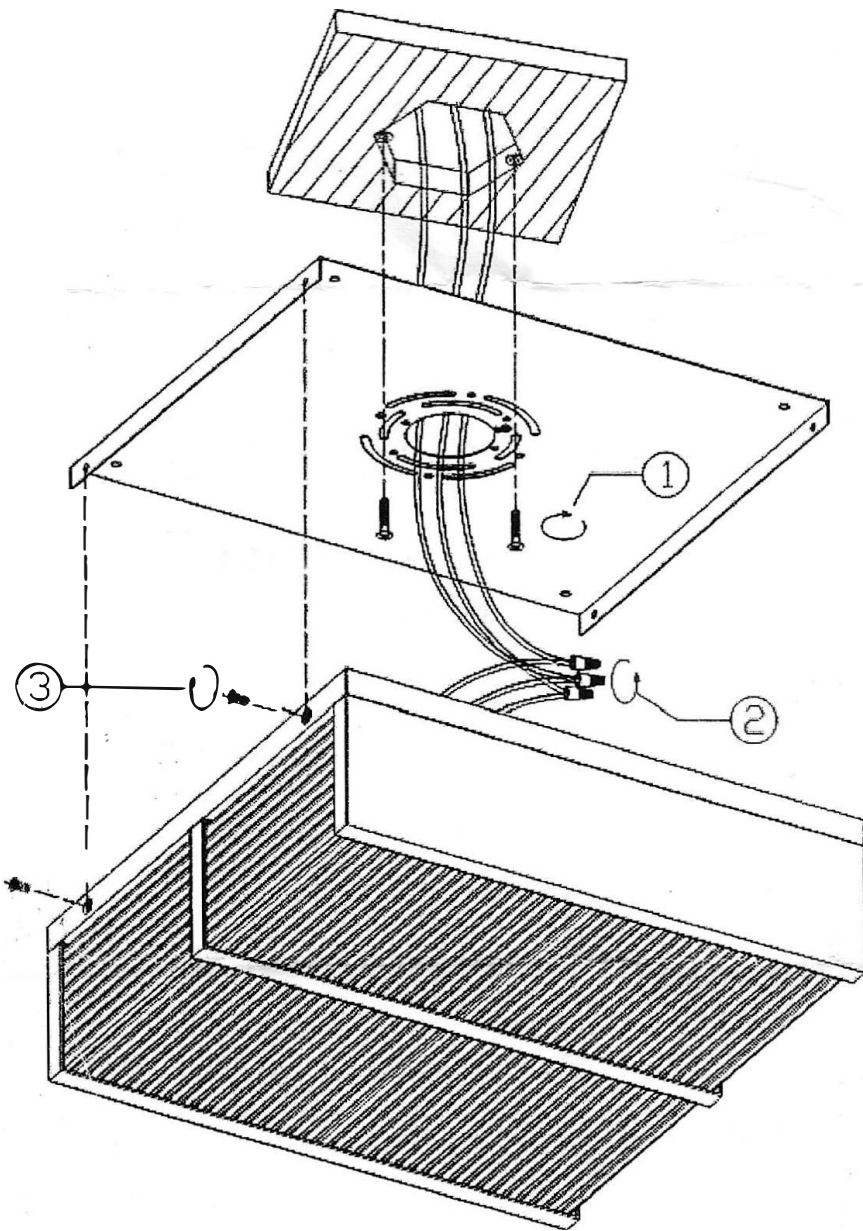

A: Copper ground wire to ground wire-if you only have two wires coming from the electrical box, connect the fixture's copper wire to the green ground screw on the mounting plate.

B: White fixture wire to white supply wire.

C: Black Fixture wire to black supply wire.