

# HF3920-BK

# AVE

L I G H T I N G

## Fixture Style

### Thank you for your purchase.

Welcome to the Avenue Lighting Family. Please follow these instructions carefully as they contain important information about the safety, use and disposal of this product. Read and understand all instructions before proceeding with assembly and installation of this fixture.

- This fixture **MUST** be installed by a licensed electrician.
- Read & understand the entire installation sheet.
- DO NOT** substitute any parts, leave parts out, or use parts that are worn out or broken.
- Suitable for the use of 110-130V and 60Hz
- Please wear gloves during installation to avoid damage to the plating.
- Must be installed in a fixed location and be checked yearly.
- Please turn off the light source with a soft cloth as cleaning with a detergent is prohibited.

### Preparation:

Carefully remove the fixture from the carton and check that all parts are included as shown in the illustration. If any parts are missing or damaged, DO NOT attempt to assemble the product.

### Tools Required (not included):

Phillips screwdriver	Electrical Tape
Flathead screwdriver	Ladder
Wire Strippers	Safety Glasses

### This package includes:

2 x Junction Box Screws  
3 x Wire Connectors

### Assembly Instructions:

1. Please turn off the power before installing the lamp [see figure A]
2. Remove the mounting bracket from the top box, then place the mounting bracket on the junction box. Next tighten with the junction box screw.
3. Connect the NEUTRAL WIRE from junction box to NEUTRAL (WHITE) wire from fixture with a wire nut. Connect the LIVE WIRE from junction box to LIVE (BLACK) wire from fixture with a wire nut.
4. Wrap the naked copper in the junction box around the green screw. Lock the green screw in the tooth hole. Connect the grounding wire of the lamp and the naked copper of the junction box with the terminal.
5. Fix the U shape steel buckle on the steel rope inside canopy to the keel.
6. Secure the big canopy to the mounting plate with decorative nuts and fix small canopy with side screws.
7. For hanging straight down style instead of necklace, please make use of the decorative knob from accessories bag. Need cut the steel rope by qualified electrician from the small canopy and insert into the decorative knob.
8. When installing the fixture, please do not over-bend the lamp body in order to avoid connection metal parts scratch.
9. Turn on the power [see figure B]

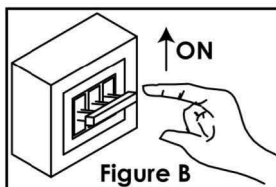
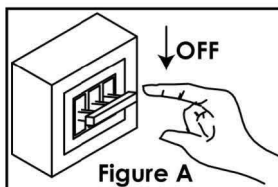
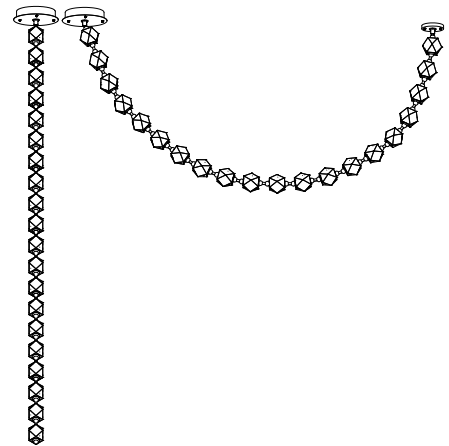

**Clean with a soft damp cloth.**  
[www.AvenueLighting.com](http://www.AvenueLighting.com)



**Intertek**  
5028385

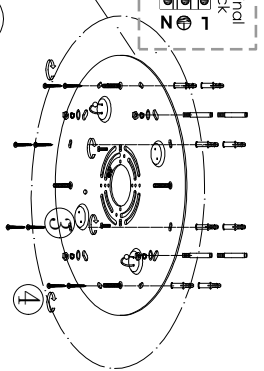
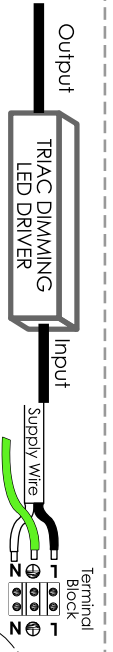

Push the ball to the bottom and lock

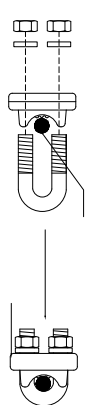
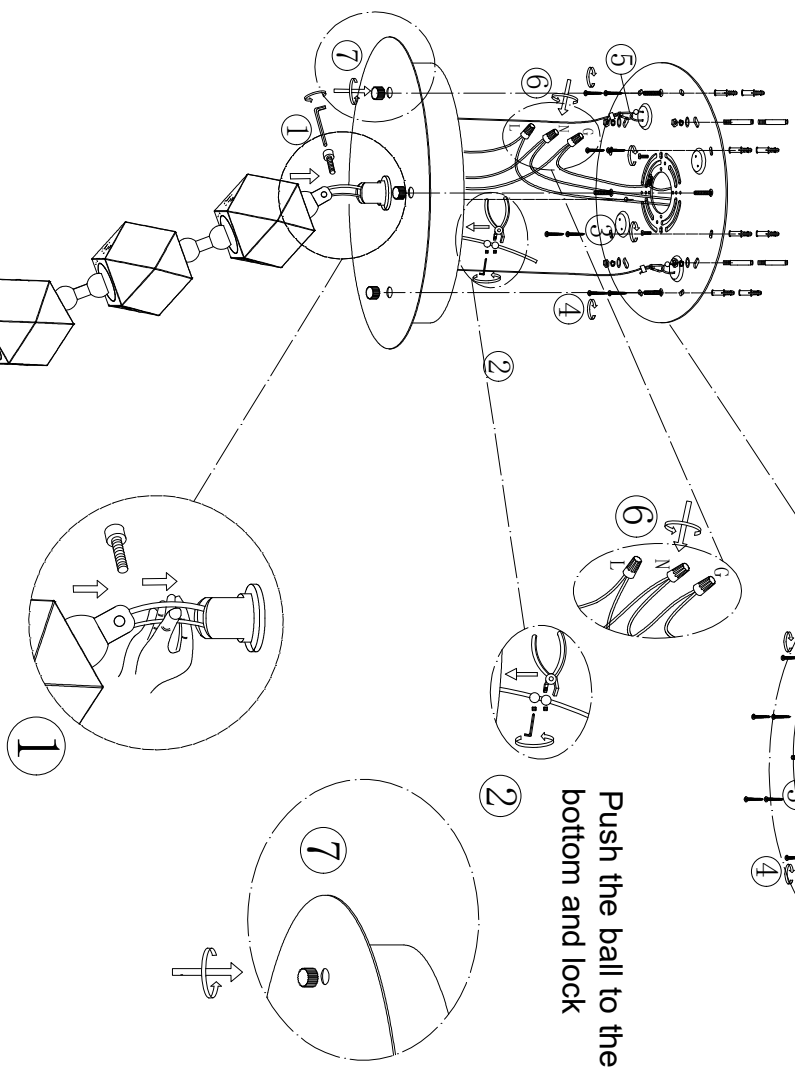

steel safety wire

steel buckle The steel buckle is used for fixing steel safety wire

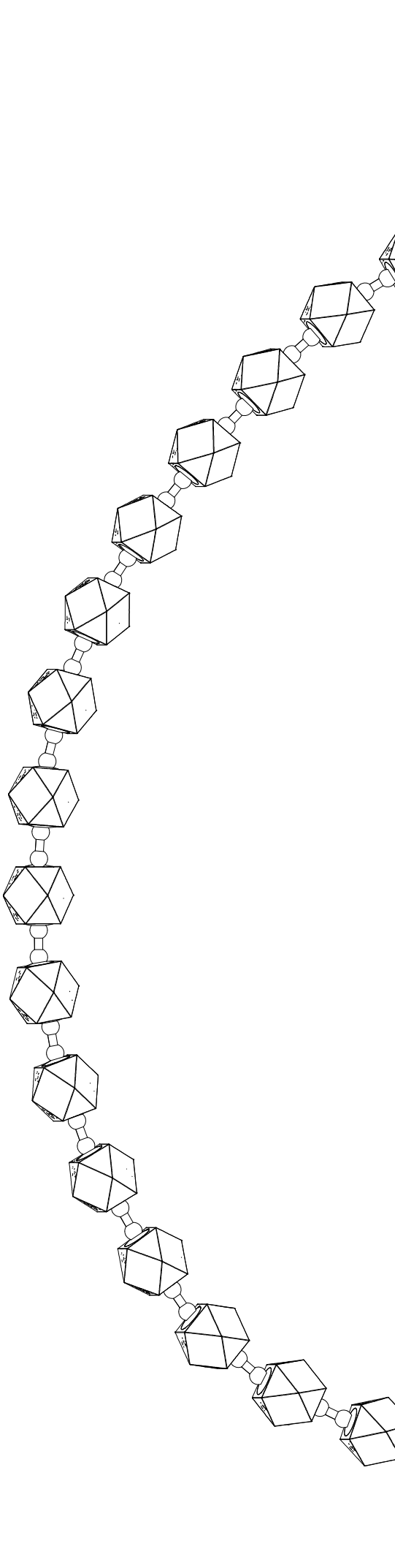
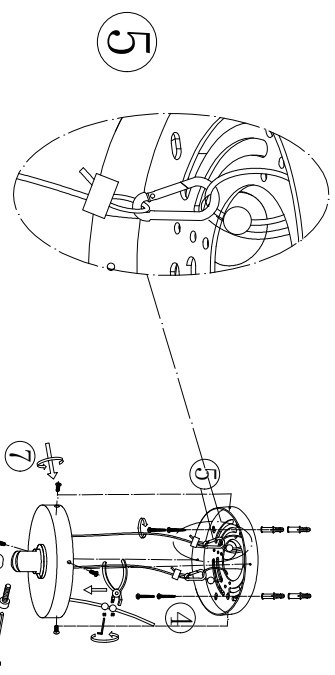

# Necklace change to straight down style diagram

