



START FROM HERE

Fixture must be installed by a licensed electrician.
Prepare everything in a clear area.
Wear gloves at all times during this installation.
Read instructions carefully before you start assembly.
Keep this instruction sheet for future reference

AV2418

WALL LIGHT

Suitable for wet location

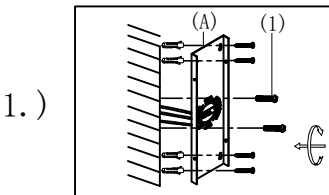

Step 1: Remove mounting bracket from fixture and install to electrical box.

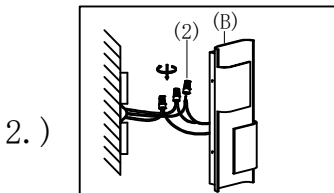

Step 2: Use wire nuts supplied to wire fixture to wires in outlet box. Copper wire is for Ground.

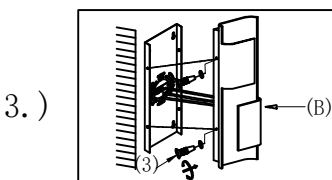

Step 3: Place the fixture on the back plate, and secure with two screws on the sides to hold the fixture in place. Caulk around back-plate where fixture meets the wall using outdoor silicone sealant. Leave a small gap at the bottom to allow moisture to escape.

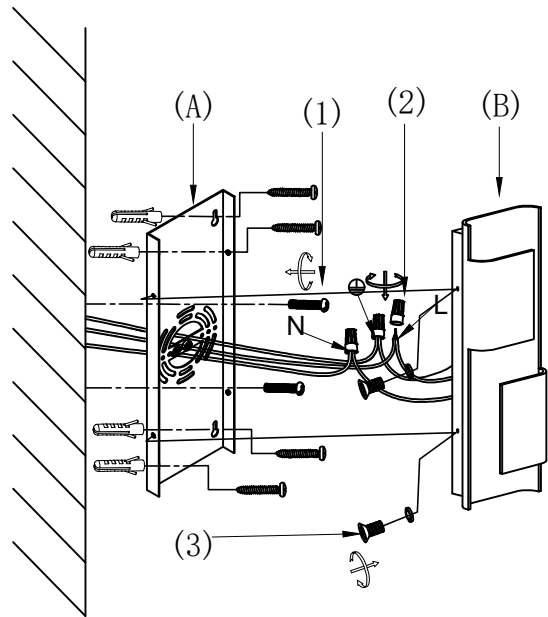

To prevent moisture from entering the outlet box and causing a short, seal around the top and side perimeter between the fixture and the wall surface with weather resistant caulking (see illustration a).

The space at bottom should be left un-caulked to prevent moisture build-up. Apply a small amount of weather resistant caulking around the side perimeter between the cap nut and mounting plate.

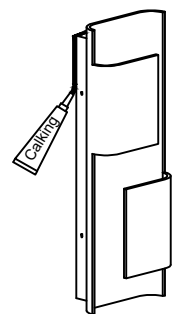

illustration a

Clean with a soft damp cloth.



www.AvenueLighting.com